

Алматы (7273)495-231
Ангарск (3955)60-70-56
Архангельск (8182)63-90-72
Астрахань (8512)99-46-04
Барнаул (3852)73-04-60
Белгород (4722)40-23-64
Благовещенск (4162)22-76-07
Брянск (4832)59-03-52
Владивосток (423)249-28-31
Владикавказ (8672)28-90-48
Владимир (4922)49-43-18
Волгоград (844)278-03-48
Вологда (8172)26-41-59
Воронеж (473)204-51-73
Екатеринбург (343)384-55-89

Иваново (4932)77-34-06
Ижевск (3412)26-03-58
Иркутск (395)279-98-46
Казань (843)206-01-48
Калининград (4012)72-03-81
Калуга (4842)92-23-67
Кемерово (3842)65-04-62
Киров (8332)68-02-04
Коломна (4966)23-41-49
Кострома (4942)77-07-48
Краснодар (861)203-40-90
Красноярск (391)204-63-61
Курск (4712)77-13-04
Курган (3522)50-90-47
Липецк (4742)52-20-81

Магнитогорск (3519)55-03-13
Москва (495)268-04-70
Мурманск (8152)59-64-93
Набережные Челны (8552)20-53-41
Нижний Новгород (831)429-08-12
Новокузнецк (3843)20-46-81
Ноябрьск (3496)41-32-12
Новосибирск (383)227-86-73
Омск (3812)21-46-40
Орел (4862)44-53-42
Оренбург (3532)37-68-04
Пенза (8412)22-31-16
Петрозаводск (8142)55-98-37
Псков (8112)59-10-37
Пермь (342)205-81-47

Ростов-на-Дону (863)308-18-15
Рязань (4912)46-61-64
Самара (846)206-03-16
Санкт-Петербург (812)309-46-40
Саратов (845)249-38-78
Севастополь (8692)22-31-93
Саранск (8342)22-96-24
Симферополь (3652)67-13-56
Смоленск (4812)29-41-54
Сочи (862)225-72-31
Ставрополь (8652)20-65-13
Сургут (3462)77-98-35
Сыктывкар (8212)25-95-17
Тамбов (4752)50-40-97
Тверь (4822)63-31-35

Тольятти (8482)63-91-07
Томск (3822)98-41-53
Тула (4872)33-79-87
Тюмень (3452)66-21-18
Ульяновск (8422)24-23-59
Улан-Удэ (3012)59-97-51
Уфа (347)229-48-12
Хабаровск (4212)92-98-04
Чебоксары (8352)28-53-07
Челябинск (351)202-03-61
Череповец (8202)49-03-64
Чита (3022)38-34-83
Якутск (4112)23-90-97
Ярославль (4852)69-52-93

Россия +7(495)268-04-70

Казахстан +7(7172)727-132

Киргизия +996(312)96-26-47

<https://laswim.nt-rt.ru/> || aiw@nt-rt.ru

COMPETITION POOL EQUIPMENT



STARTING PLATFORMS

STARTING PLATFORMS

COMPETITION POOL EQUIPMENT

Universally acclaimed by coaches and competitive swimmers, this platform is graceful and functionally simplistic. It meets FINA requirements. The surface area is covered with non-slip material.



WL-ACF01 Standard Starting Platform

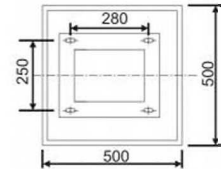
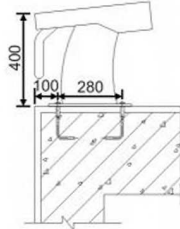

WL-ACF02 SS Two Steps Starting Platform

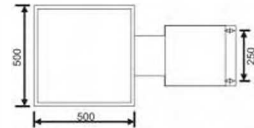
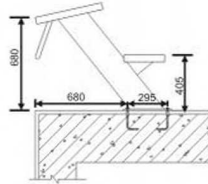

WL-ACF03 Standard Starting Platform

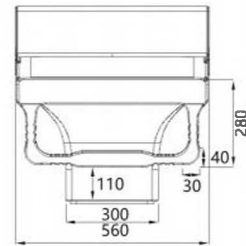
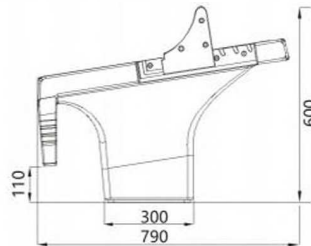

WL-BCF01 Standard Starting Platform

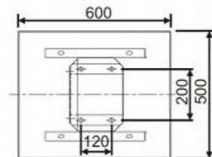
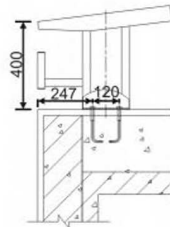

WL-BCF02 Standard Starting Platform

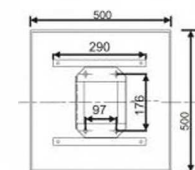
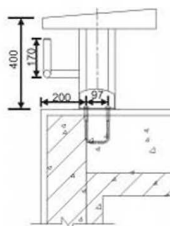



WL-ACF05 Standard Starting Platform

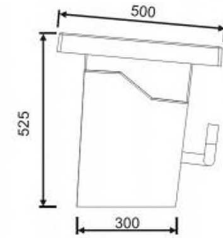
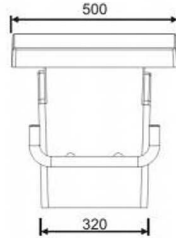

WL-ACF06 Standard Starting Platform

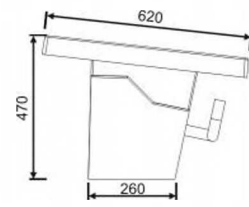
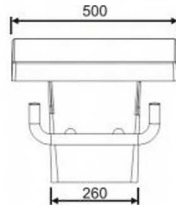

WL-ACF07 Standard Starting Platform

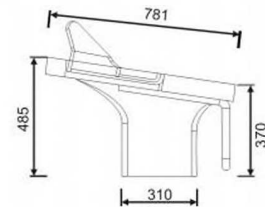
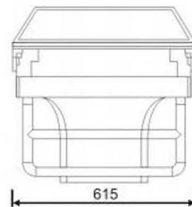

STORAGE REEL COMPETITION POOL EQUIPMENT



WL-AJX01

Made of stainless steel, provided with a large diameter wheel for line collection, mounted on 2 wheels for moving around. It is very strong and durable. Holds one 50m or two 25m lanes. Maintenance free. It is ideal lane reel for commercial and institutional pools.

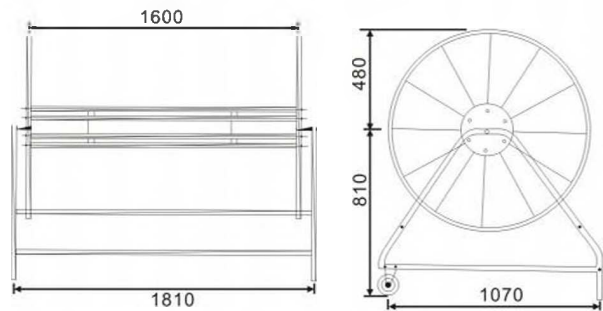

RACING LANE LINE



Racing Lane's flow-through design controls water turbulence by allowing wave energy to be dispersed along the length of the lane, creating the optimum environment for the fastest swim times.

Each lane consists of a series of ϕ 120 or ϕ 150mm polyethylene disks and donuts strung on a stainless steel cable. Each of these disks is designed to rotate independently of the others, thereby allowing the wave energy to be absorbed and dispersed along the channel within the lane. Competitor lanes come completely assembled.

Standard Colors - Red, White, Blue, Yellow, Green.



Model	Specification
WL-BYD101	ϕ 150x25m
WL-BYD102	ϕ 150x50m
WL-BYD201	ϕ 120x25m
WL-BYD202	ϕ 120x50m

UNDERWATER OBSERVATION WINDOW COMPETITION POOL EQUIPMENT

A valuable aid to instruction and coaches, underwater observation windows are relatively easy to build into swimming pool and diving pool under construction and virtually impossible to add afterwards. They are extra heavy duty, engineered for safety and minimum optical distortion. Framing and hardware are stainless steel, with glazing made of Bullet Resistant Glazing. Far safer than tempered glass, these glazes are specified for use in military underwater applications. All windows are shipped factory sealed and pressure tested.



Rectangular Underwater Observation Window

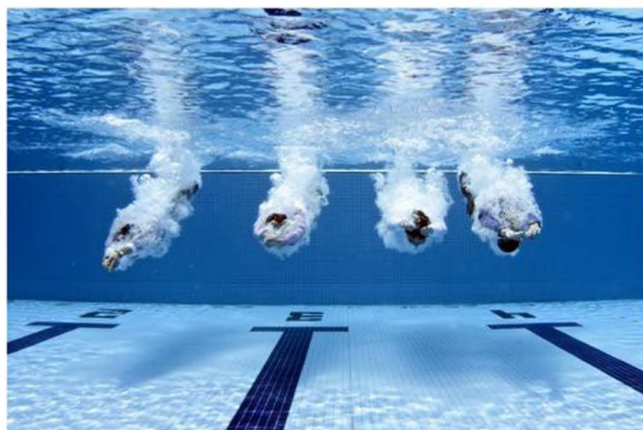

Round Underwater Observation Window

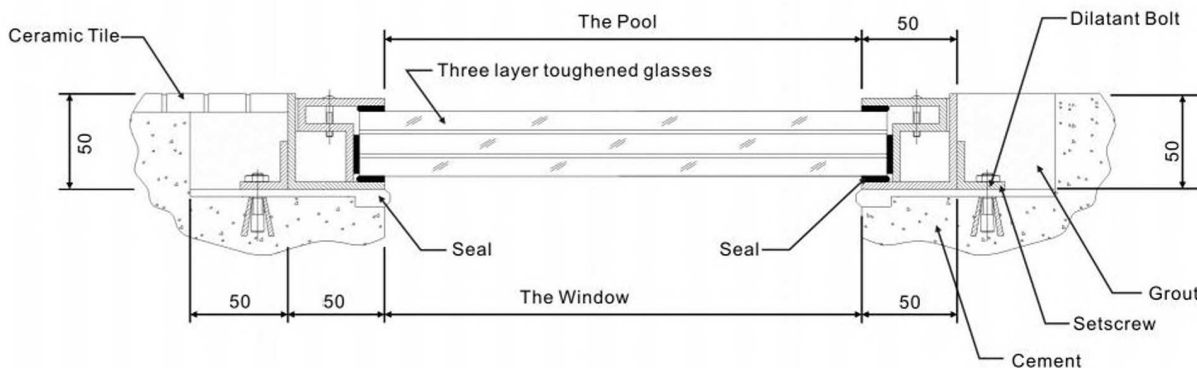

Name	Model	Length/height (Can be made by special order)	Width (Can be made by special order)
Underwater Observation Window(Rectangular)	WL-AGC11	900mm	900mm
Underwater Observation Window(Rectangular)	WL-AGC12	1200mm	900mm
Underwater Observation Window(Round)	WL-AGC21		Φ565mm

Алматы (7273)495-231
Ангарск (3955)60-70-56
Архангельск (8182)63-90-72
Астрахань (8512)99-46-04
Барнаул (3852)73-04-60
Белгород (4722)40-23-64
Благовещенск (4162)22-76-07
Брянск (4832)59-03-52
Владивосток (423)249-28-31
Владикавказ (8672)28-90-48
Владимир (4922)49-43-18
Волгоград (844)278-03-48
Вологда (8172)26-41-59
Воронеж (473)204-51-73
Екатеринбург (343)384-55-89

Иваново (4932)77-34-06
Ижевск (3412)26-03-58
Иркутск (395)279-98-46
Казань (843)206-01-48
Калининград (4012)72-03-81
Калуга (4842)92-23-67
Кемерово (3842)65-04-62
Киров (8332)68-02-04
Коломна (4966)23-41-49
Кострома (4942)77-07-48
Краснодар (861)203-40-90
Красноярск (391)204-63-61
Курск (4712)77-13-04
Курган (3522)50-90-47
Липецк (4742)52-20-81

Магнитогорск (3519)55-03-13
Москва (495)268-04-70
Мурманск (8152)59-64-93
Набережные Челны (8552)20-53-41
Нижний Новгород (831)429-08-12
Новокузнецк (3843)20-46-81
Ноябрьск (3496)41-32-12
Новосибирск (383)227-86-73
Омск (3812)21-46-40
Орел (4862)44-53-42
Оренбург (3532)37-68-04
Пенза (8412)22-31-16
Петрозаводск (8142)55-98-37
Псков (8112)59-10-37
Пермь (342)205-81-47

Ростов-на-Дону (863)308-18-15
Рязань (4912)46-61-64
Самара (846)206-03-16
Санкт-Петербург (812)309-46-40
Саратов (845)249-38-78
Севастополь (8692)22-31-93
Саранск (8342)22-96-24
Симферополь (3652)67-13-56
Смоленск (4812)29-41-54
Сочи (862)225-72-31
Ставрополь (8652)20-65-13
Сургут (3462)77-98-35
Сыктывкар (8212)25-95-17
Тамбов (4752)50-40-97
Тверь (4822)63-31-35

Тольятти (8482)63-91-07
Томск (3822)98-41-53
Тула (4872)33-79-87
Тюмень (3452)66-21-18
Ульяновск (8422)24-23-59
Улан-Удэ (3012)59-97-51
Уфа (347)229-48-12
Хабаровск (4212)92-98-04
Чебоксары (8352)28-53-07
Челябинск (351)202-03-61
Череповец (8202)49-02-64
Чита (3022)38-34-83
Житомир (4112)23-90-97
Ярославль (4852)69-52-93

Россия +7(495)268-04-70

Казахстан +7(7172)727-132

Киргизия +996(312)96-26-47

<https://laswim.nt-rt.ru/> || aiw@nt-rt.ru