

Алматы (7273)495-231
 Ангарск (3955)60-70-56
 Архангельск (8182)63-90-72
 Астрахань (8512)99-46-04
 Барнаул (3852)73-04-60
 Белгород (4722)40-23-64
 Благоевский (4162)22-76-07
 Брянск (4832)59-03-52
 Владивосток (423)249-28-31
 Владикавказ (8672)28-90-48
 Владимир (4922)49-43-18
 Волгоград (844)276-03-48
 Вологда (8172)26-41-59
 Воронеж (473)204-51-73
 Екатеринбург (343)384-55-89

Иваново (4932)77-34-06
 Ижевск (3412)26-03-58
 Иркутск (395)279-98-46
 Казань (843)206-01-48
 Калининград (4012)72-03-81
 Калуга (4842)92-23-67
 Кемерово (3842)65-04-62
 Киров (8332)68-02-04
 Коломна (4966)23-41-49
 Кострома (4942)77-07-48
 Краснодар (861)203-40-90
 Красноярск (391)204-63-61
 Курск (4712)77-13-04
 Курган (3522)50-90-47
 Липецк (4742)52-20-81

Магнитогорск (3519)55-03-13
 Москва (495)268-04-70
 Мурманск (8152)59-64-93
 Набережные Челны (8552)20-53-41
 Нижний Новгород (831)429-08-12
 Новокузнецк (3843)20-46-81
 Ноябрьск (3496)41-32-12
 Новосибирск (383)227-86-73
 Омск (3812)21-46-40
 Орел (4862)44-53-42
 Оренбург (3532)37-68-04
 Пенза (8412)22-31-16
 Петрозаводск (8142)55-98-37
 Пермь (812)56-10-37
 Пермь (342)205-81-47

Ростов-на-Дону (863)308-18-15
 Рязань (4912)46-61-64
 Самара (846)206-03-16
 Санкт-Петербург (812)309-46-40
 Саратов (845)249-38-78
 Севастополь (8692)22-31-93
 Саранск (8342)22-96-24
 Симферополь (3652)67-13-56
 Смоленск (4812)29-41-54
 Сочи (862)225-72-31
 Ставрополь (8652)20-65-13
 Сурагут (3462)77-98-35
 Сургут (821)225-95-17
 Тамбов (4752)50-40-87
 Тверь (4822)63-31-35

Тольятти (8482)63-91-07
 Томск (3822)98-41-53
 Тула (4872)33-79-87
 Тюмень (3452)66-21-18
 Ульяновск (8422)24-23-59
 Улан-Удэ (3012)59-97-51
 Уфа (347)229-48-12
 Хабаровск (4212)92-98-04
 Челябинск (351)202-03-61
 Череповец (8202)48-02-64
 Чита (3022)38-34-85
 Якутск (4112)29-90-97
 Ярославль (4652)69-52-93

Россия +7(495)268-04-70

Казахстан +7(7172)727-132

Киргизия +996(312)96-26-47

<https://laswim.nt-rt.ru/> || aiw@nt-rt.ru

MAIN DRAINS

The main drains are available in a wide range of styles and sizes to satisfy any installation requirement of any concrete residential or commercial pools. These main drains are injection-molded of ABS, which resists chemical attack.



Products	Round Main Drain
Model	WL-ADP197
Colour	White
Material	ABS

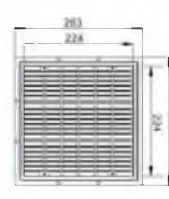

Model	WL-ADP263
Size	263X263mm
Colour	White
Thickness	35mm

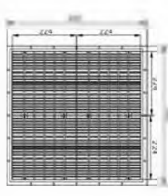
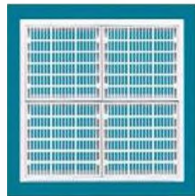

Model	WL-ADP490
Size	490X490mm
Colour	White
Thickness	66mm

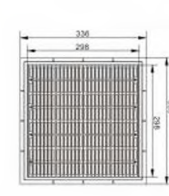
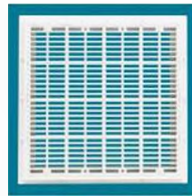

Model	WL-ADP336
Size	336X336mm
Colour	White
Thickness	35mm



Products	Drains
Model	PADF1467C
Colour	White
Material	ABS

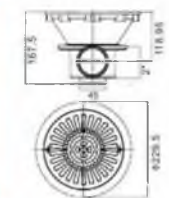

Products	Drains
Model	PADF1467V
Colour	White
Material	ABS

ANTI-SUCTION MAIN DRAINS

POOL FITTINGS & CLEANERS

Features:

- Curved surface design, anti-suction.
- VGB compliant and tested to ANSI/APSP-16 standards.
- UV-resistant, corrosion resistant, not easy to fade, longer life time.
- Meets various flow rate requirements.

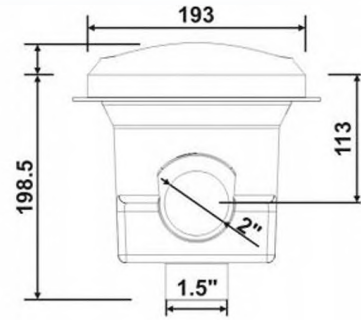
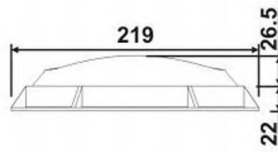
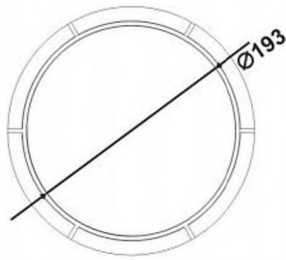

WL-JDP200AL

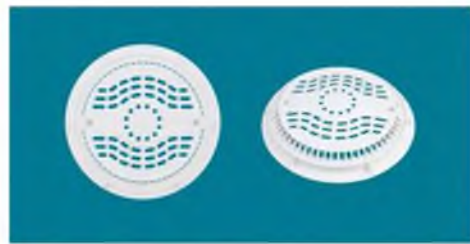

WL-JDP200BL



WL-JDP200AH



WL-JDP200BH

Model	Specification	Outlet	Cover Dia. (mm)	Height	Material	Max Flow Rate (m ³ /h)
WL-JDP200AL	cover + frame	—	193	22	ABS	33.5
WL-JDP200AH	cover+ body	side 2 bottom 1.5"	193	198.5	ABS	33.5
WL-JDP200BL	cover + frame	—	193	22	ABS	33.5
WL-JDP200BH	cover+ body	side 2 bottom 1.5"	193	198.5	ABS	33.5

ANTI-SUCTION MAIN DRAINS POOL FITTINGS & CLEANERS

Features:

- Curved surface design, anti-suction.
- VGB compliant and tested to ANSI/APSP-7,2006 standards.
- Manufactured from UV- resistant engineered polymers.
- Used in new construction or to retrofit into existing Laswim frames.
- Meets various flow rate requirements.

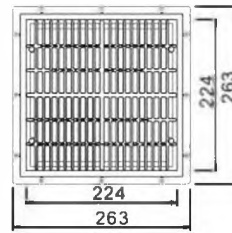

WL-FDP9"

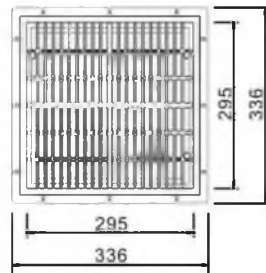

WL-FDP12"

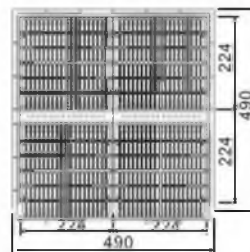

WL-FDP18"

Model	Size (inch/ mm)	Thickness (mm)	Material	Design Flow (m ³ /h)
WL-FDP9"	9" x 9" 263mm x 263mm	70	ABS	23
WL-FDP12"	12" x 12" 336mm x 336mm	78	ABS	88
WL-FDP18"	18" x 18" 490mm x 490mm	100	ABS	93

GUTTER GRATINGS

POOL FITTINGS & CLEANERS

Gutter grating is molded in white UV resistant ABS. Top of grating features an anti-slip finish and it is composed of individual units connecting along a central spine. This design allows for easier installation without the need for cutting also allowing the grating to curve as necessary.

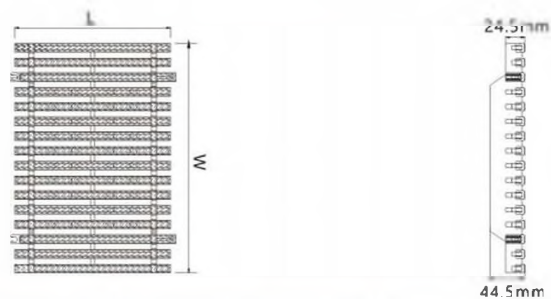
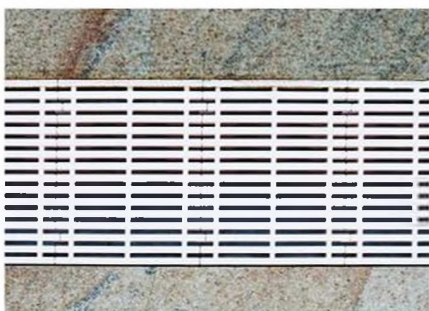
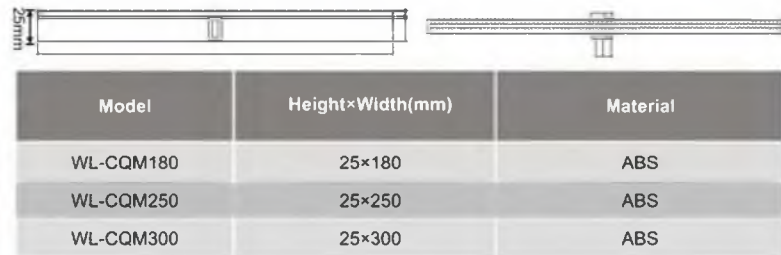
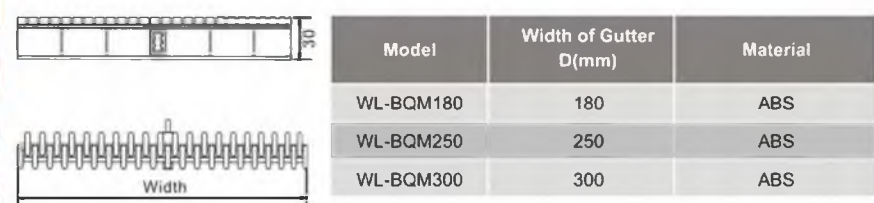
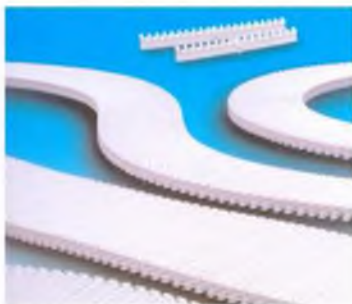
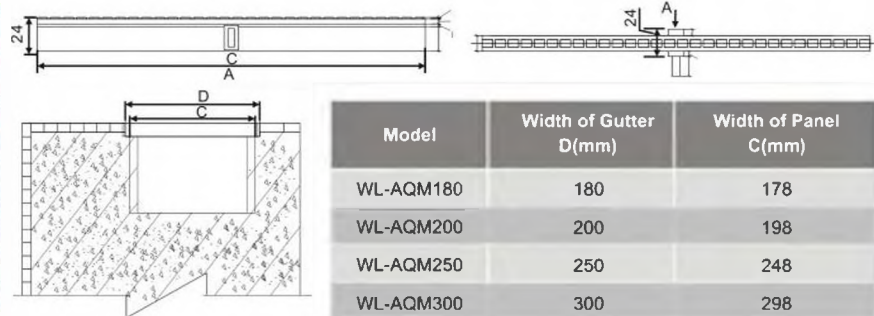

Model	Width×Length(mm)	Material
WL-DQM300	300×200	ABS
WL-DQM350	350×250	ABS
WL-DQM375	375×250	ABS

GUTTER GRATINGS POOL FITTINGS & CLEANERS

Features:

- Comply with the standard of EN-13451 and CJJ122-2008.
- Anti-slip, safe, super strong, durable.
- UV-resistant, not easy to fade or break, longer using life.
- To be easy to install and flexible to meet a variety of different swimming pool specifications.
- Composed of Part A and Part B as below drawing, Length is adjustable.
- Can make an arc with minimum radius of 625mm.

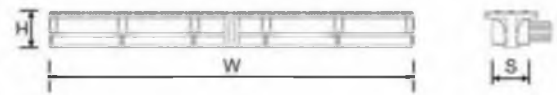
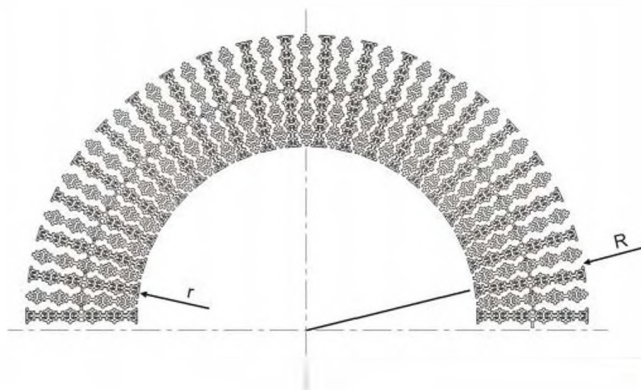
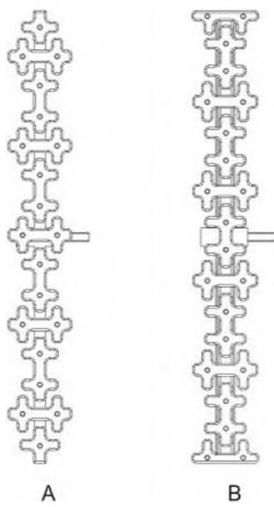
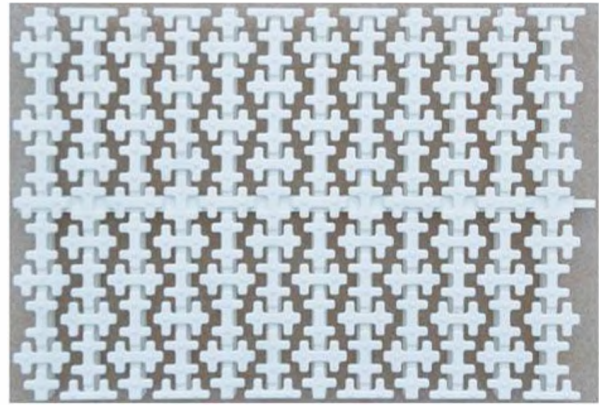

Model	W(mm)	S(mm)	H(mm)	R(mm)	r(mm)
WL-HQM250	250	29	25	625	375

Алматы (7273)495-231
Ангарск (3955)00-70-50
Архангельск (8162)63-90-72
Астрахань (8512)99-46-04
Барнаул (3852)73-04-80
Белгород (4722)40-23-64
Благовещенск (4162)22-76-07
Брянск (4832)59-03-62
Владивосток (423)249-28-31
Владикавказ (8672)28-90-48
Владимир (4822)49-43-18
Волгоград (844)278-03-48
Волгодла (8172)26-41-59
Воронеж (473)204-51-73
Екатеринбург (343)384-55-89

Иваново (4932)77-34-06
Ижевск (3412)26-03-58
Иркутск (395)279-98-46
Казань (843)206-01-48
Калининград (4012)72-03-81
Калуга (4842)02-23-67
Кемерово (3842)65-04-62
Киров (8332)68-02-04
Коломна (4966)23-41-49
Кострома (4942)77-07-48
Краснодар (861)203-40-90
Красноярск (391)204-63-61
Курск (4712)77-13-04
Курган (3522)50-90-47
Липецк (4742)62-20-81

Магнитогорск (3519)55-03-13
Москва (495)268-04-70
Мурманск (8152)59-64-93
Набережные Челны (8552)00-53-41
Нижний Новгород (831)429-08-12
Новокузнецк (3843)20-46-81
Новосибирск (383)227-86-73
Омск (3812)21-46-40
Орел (4862)44-53-42
Оренбург (3532)37-68-04
Пенза (8412)22-31-16
Петрозаводск (8142)55-98-37
Псков (8112)59-10-37
Пермь (342)205-81-47

Ростов-на-Дону (863)308-18-15
Рязань (4912)46-61-64
Самара (846)206-03-16
Санкт-Петербург (812)309-46-40
Саратов (845)249-38-78
Севастополь (8692)22-31-93
Саранск (8342)22-96-24
Симферополь (3652)67-13-56
Смоленск (4812)29-41-54
Сочи (862)225-72-31
Ставрополь (8652)20-65-13
Сургут (3462)77-98-35
Сыктывкар (8212)25-95-17
Тамбов (4752)50-40-97
Тверь (4822)63-31-35

Тольятти (8482)63-91-07
Томск (3822)88-41-53
Тула (4872)33-78-87
Тюмень (3452)66-21-18
Ульяновск (8422)24-23-59
Улан-Удэ (3012)59-97-51
Уфа (347)229-48-12
Хабаровск (4212)92-98-04
Чебоксары (8352)28-53-07
Челябинск (351)202-03-61
Череповец (8202)49-02-64
Чита (3022)38-34-83
Якутск (4112)23-90-97
Ярославль (4852)69-52-93

Россия +7(495)268-04-70

Казахстан +7(7172)727-132

Киргизия +996(312)96-26-47

<https://laswim.nt-rt.ru/> || aiw@nt-rt.ru